

SPECIFICATIONS

- CONTACT RATING:** Dependent upon contact material.
- MECHANICAL LIFE:** 40,000 make-and-break cycles.
- CONTACT RESISTANCE:** 10mΩ max. initial @ 2-4VDC
100mA for both silver and gold plated contacts.
- INSULATION RESISTANCE:** 1,000MΩ min.
- DIELECTRIC STRENGTH:** 1,000 V RMS@sea level.
- OPERATING TEMPERATURE:** -30°C to 85°C.

MATERIALS

- CASE:** Diallyl phthalate (DAP) (UL94v-0).
- ACTUATOR:** Brass,chrome plated.
- BUSHING:** Brass,nickel plated.
- HOUSING:** Stainless Steel.
- SWITCH SUPPORT:** Brass,tin plated.
- TERMINAL/CONTACT:** Silver or gold plated.(See Page 11)

HOW TO ORDER

MODEL NO.	ACTUATOR	BUSHING	TERMINATIONS	CONTACT MATERIAL	SEAL	ROHS SOLDERING
<p>MODEL NO.</p> <p>1MS1 SP On-None-On</p> <p>1MS2 SP On-None-Mom</p> <p>1MS3 SP On-Off-On</p> <p>1MS4 SP Mom-Off-Mom</p> <p>1MS5 SP On-Off-Mom</p> <p>1MD1 DP On-None-On</p> <p>1MD2 DP On-None-Mom</p> <p>1MD3 DP On-Off-On</p> <p>1MD4 DP Mom-Off-Mom</p> <p>1MD5 DP On-Off-Mom</p> <p>1MD6 DP On-On-On</p> <p>1MD7 DP MOM-On-Mom</p> <p>1MD8 DP On-On-Mom</p> <p>1M31 3P On-None-On</p> <p>1M32 3P On-None-Mom</p> <p>1M33 3P On-Off-On</p> <p>1M34 3P Mom-Off-Mom.</p> <p>1M35 3P On-Off-Mom</p> <p>1M41 4P On-None-On</p> <p>1M42 4P On-None-Mom</p> <p>1M43 4P On-Off-On</p> <p>1M44 4P Mom-Off-Mom</p> <p>1M45 4P On-Off-Mom</p> <p>1M46 4P On-On-On</p> <p>1M47 4P MOM-On-Mom</p> <p>1M48 4P On-On-Mom</p>	<p>ACTUATOR</p> <p>T1 10.41 high</p> <p>T2 5.08 high</p> <p>T3 13.97 high</p> <p>T4 16.26 high</p> <p>T5 21.34 high</p> <p>T6 Flatted,anti-rotation</p> <p>T61 Flatted,anti-rotation</p> <p>T62 Lever handle with cap</p> <p>13.49 high</p> <p>T63 Flatted,anti-rotation</p> <p>6.35 high</p> <p>T7 12.37 high,15/32 bushing</p> <p>T8 17.56 high,15/32 bushing</p> <p>T9 Plastic,21.3 high</p> <p>TA 26.30 high lever handle</p> <p>with cap,15/32 bushing</p> <p>T11 Plastic,12.2 high</p> <p>TL1 Locking lever 16.00 high</p> <p>TL2 Locking lever 16.26 high</p> <p>TL3 Locking lever 17.28 high</p>	<p>BUSHING</p> <p>B1 8.89 high,keyway (thd std)</p> <p>B2 8.89 high,keyway (non-thd)</p> <p>B3 7.10 high,keyway (thd)</p> <p>B4 7.10 high,keyway (non-thd)</p> <p>B5 7.52 high,flat (torque)</p> <p>B6 8.00 high,keyway (torque)</p> <p>B7 8.89 high,flat (thd std)</p> <p>B8 8.89 high,keyway (metric thd)</p> <p>B9 7.52 high,flat (splash proof)</p> <p>B11 7.55 high,keyway (thd std)</p> <p>B12 7.55 high,keyway (non-thd)</p> <p>B13 11.38 high,keyway (15/32 bushing)</p> <p>B14 11.90 high,flat (splash proof)</p> <p>B15 7.55 high,flat (thd std)</p> <p>B16 7.55 high,flat (non-thd)</p> <p>B17 3.50 high,keyway</p> <p>B18 11.38 high,keyway (15/32 bushing)</p> <p>B20 11.38 high,keyway (15/32 bushing)</p> <p>B25 8.00 high,keyway,locking lever (thd)</p> <p>B26 8.00 high,keyway,locking lever (non-thd)</p>	<p>TERMINATIONS</p> <p>M1 Solder Lug</p> <p>M2 PC thru-hole</p> <p>M3 Quick Connect</p> <p>M5-1 18.70 high, wire wrap</p> <p>M5-2 24.20 high, wire wrap</p> <p>M5-3 10.55 high, wire wrap</p> <p>M5-4 26.97 high, wire wrap</p> <p>M6 Right angle, PC thru-hole</p> <p>M6N Right angle, snap-in, PC thru-hole</p> <p>M7 Vertical right angle, PC thru-hole</p> <p>VS2 11.68 high, V-bracket</p> <p>V2N 11.68 high, snap-in V-bracket</p> <p>VS3 16.00 high, V-bracket</p> <p>VS4 11.68 high, V-bracket</p> <p>VS5 16.00 high, V-bracket</p>	<p>CONTACT MATERIAL</p> <p>Q Silver</p> <p>R Gold</p> <p>G Gold,pure-tin</p> <p>S Silver,pure-tin</p> <p>C Gold over silver</p> <p>K Gold over silver,pure-tin</p>	<p>SEAL</p> <p>E EPOXY (std)</p> <p>N NO EPOXY</p>	<p>ROHS SOLDERING</p> <p><input type="checkbox"/> Rohs Compliant</p> <p><input type="checkbox"/> S Rohs & Lead Free</p>

SWITCH FUNCTION

NO. POLES	UL/CSA MODEL NO.	MODEL NO.	SWITCH FUNCTION			CONNECTED TERMINALS / SCHEMATIC		
			POS.1	POS.2	POS.3	POS.1	POS.2	POS.3
SP	Q1111	1MS1	ON	NONE	ON		N/A	
	Q1112	1MS2	ON	NONE	MOM	2-3		2-1
	Q1113	1MS3	ON	OFF	ON		OPEN	
	Q1114	1MS4	MOM	OFF	MOM			
	Q1115	1MS5	ON	OFF	MOM			
DP	Q1121	1MD1	ON	NONE	ON		N/A	
	Q1122	1MD2	ON	NONE	MOM	2-3,5-6		2-1,5-4
	Q1123	1MD3	ON	OFF	ON		OPEN	
	Q1124	1MD4	MOM	OFF	MOM			
	Q1125	1MD5	ON	OFF	MOM			
	▲ Q1127	1MD7	MOM	ON	MOM	2-3,5-6	2-3,5-4	2-1,5-4
	▲ Q1128	1MD8	ON	ON	MOM			
	3P	Q1131	1M31	ON	NONE	ON		N/A
Q1132		1M32	ON	NONE	MOM	2-3,5-6,8-9		2-1,5-4,8-7
Q1133		1M33	ON	OFF	ON		OPEN	
Q1134		1M34	MOM	OFF	MOM			
Q1135		1M35	ON	OFF	MOM			
4P	Q1141	1M41	ON	NONE	ON		N/A	
	Q1142	1M42	ON	NONE	MOM	2-3,5-6,8-9,11-12		2-1,5-4,8-7,11-10
	Q1143	1M43	ON	OFF	ON		OPEN	
	Q1144	1M44	MOM	OFF	MOM			
	Q1145	1M45	ON	OFF	MOM			
	Q1146	1M46	ON	ON	ON			
	▲ Q1147	1M47	MOM	ON	MOM	2-3,5-6,8-9,11-12	2-3,5-4,8-9,11-10	2-1,5-4,8-7,11-10
	▲ Q1148	1M48	ON	ON	MOM			

MOM=MOMENTARY

▲ Please check the availability in advance before order

POLE OPTIONS

SPDT

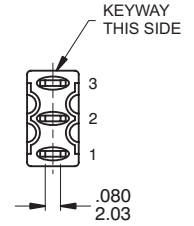
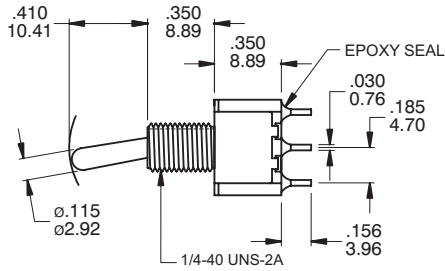
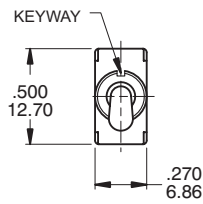

Part No. Shown : 1MS1T1B1M1QE

DPDT

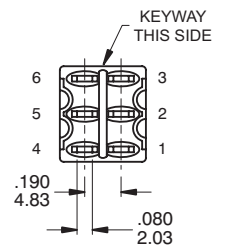
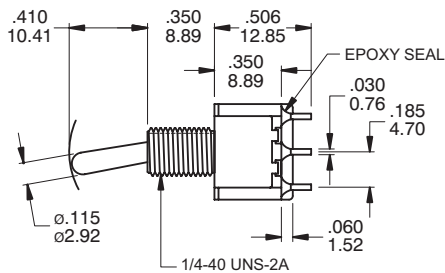
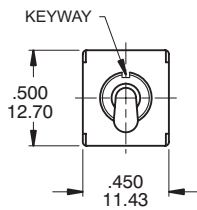

Part No. Shown : 1MD1T1B1M1QE

3PDT

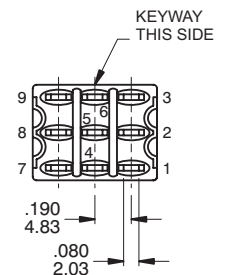
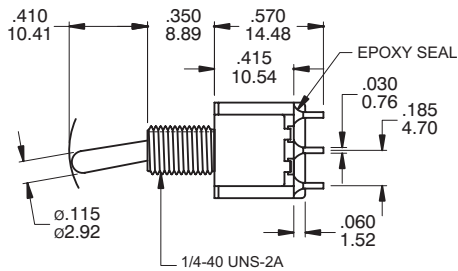
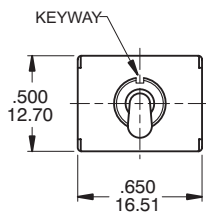

Part No. Shown : 1M31T1B1M1QE

4PDT

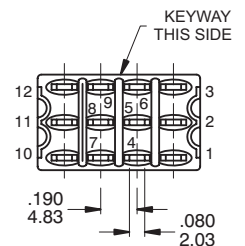
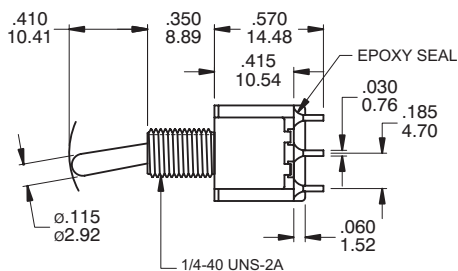
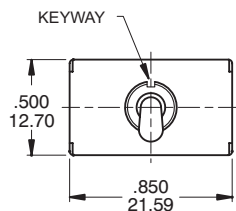

Part No. Shown : 1M41T1B1M1QE

3-WAY SWITCHES

3-WAY WIRING DIAGRAM SCHEMATICS

SINGLE POLE, 3 POSITION

Model No.	POS 1	POS 2	POS 3
1MD6	ON	ON	ON
Term. Comm.	2-3,5-6	2-3,5-4	2-1,5-4

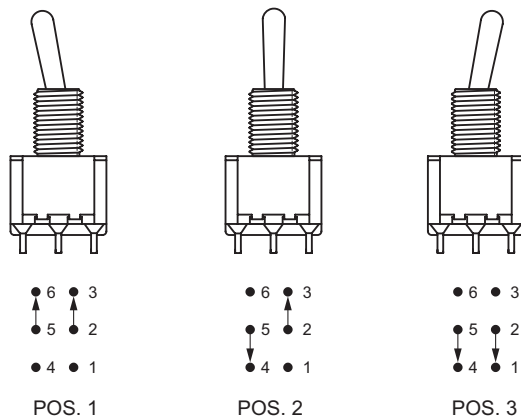
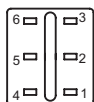
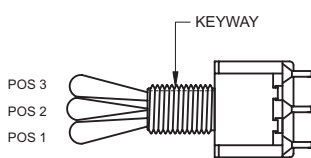

DOUBLE POLE, 3 POSITION

Model No.	POS 1	POS 2	POS 3
1M46	ON	ON	ON
Term. Comm.	2-3,5-6 8-9,11-12	2-3,5-4 8-9,11-10	2-1,5-4 8-7,11-10

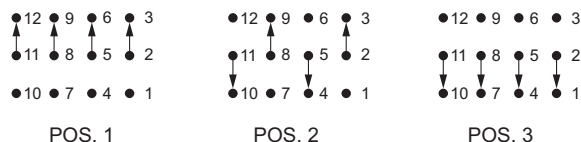
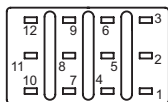

ACTUATOR OPTIONS

T1 STD

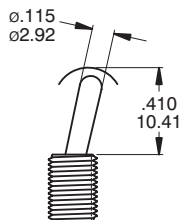

T2

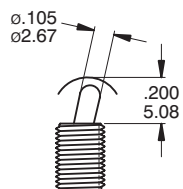

T3

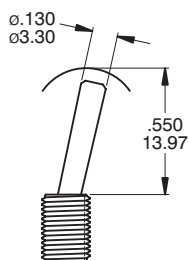

T4

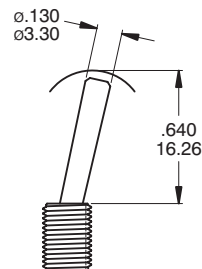

T5

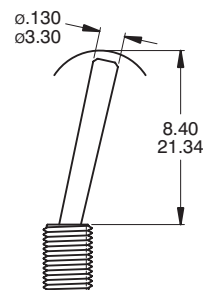

NOTE T1 ~ T5 Actuator shown with standard B1 Bushing ;
 Add .070 (1.78) for B3 Bushing ;
 Subtract .020 (0.51) for B6 Bushing ;
 Std for M1 , M2 Terminal sub .016 (0.40) for M6 , M7 , VSX

T6 FLATTED WITH ANTIROTATION

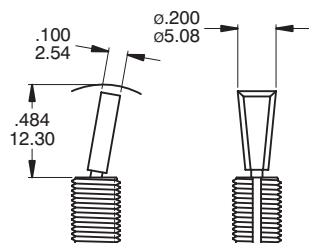

T61

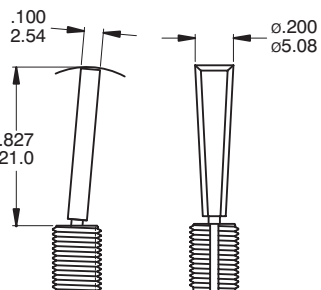

T62

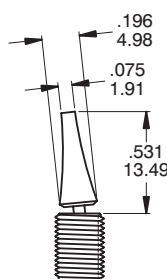

T63

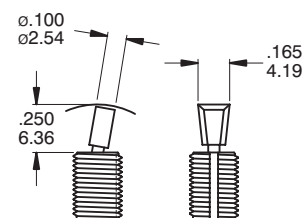

NOTE T6,T6-1,T6-2 ,T63 use with B11, B12, B15, B16 bushing only.

T7

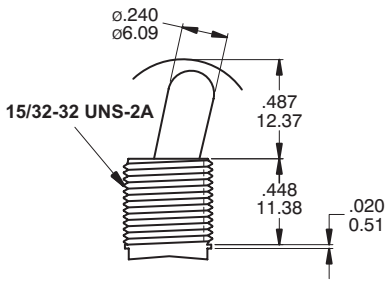

Use with B13 bushing
Use with B18,B20 the lever is antirotation and the size of lever is 13.00mm

T8

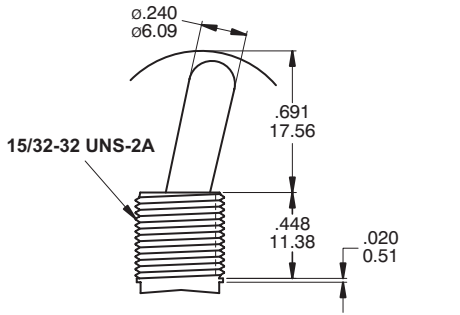

Use with B13 bushing
Use with B18,B20 the lever is antirotation and the size of lever is 18.00mm

T9

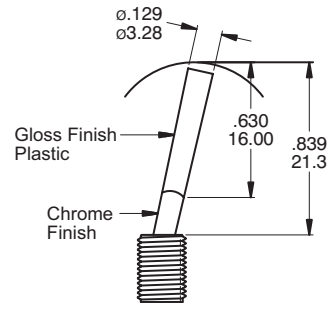

B1 / B2 bushing std with black and red color only (std.)

TA PLASTIC BLACK

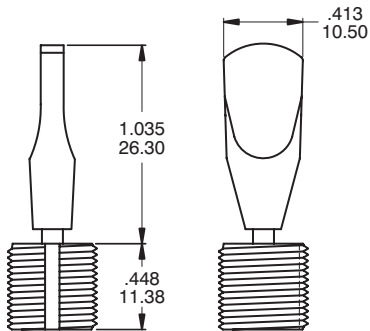

Use with B18 bushing only

T11

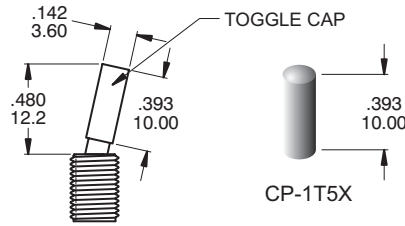

NOTE T11 Actuator shown with standard B1 Bushing ;
Add .070 (1.78) for B3 Bushing ;
Subtract .020 (0.51) for B6 Bushing.
Std for M1.M2 Terminal sub .016 (0.40) for M6.M7.VSX

Plastic No.Color :

ITEM NO	COLOR
1	White
2	Black (Std)
3	Red
4	Orange
5	Yellow
6	Green
7	Blue
8	Brown
9	Gray

T6-2 , TA , T9 , T11 ACTUATOR ONLY

TL1B25

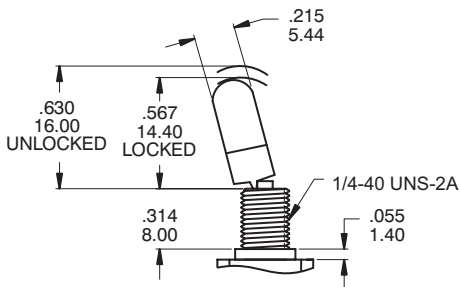

TL2B25

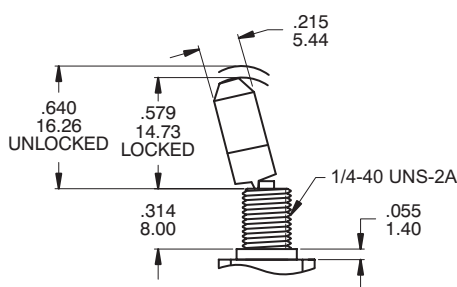

TL3B25

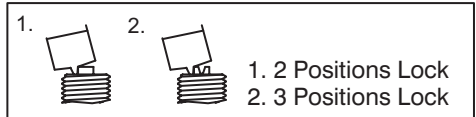
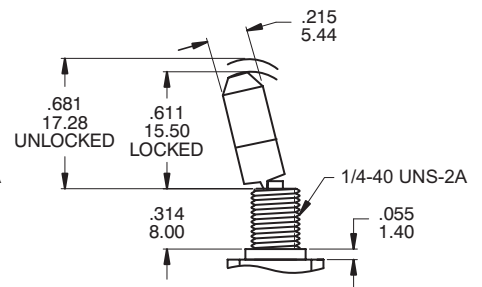

BUSHING OPTIONS

B1 THD STD B2 NON-THD

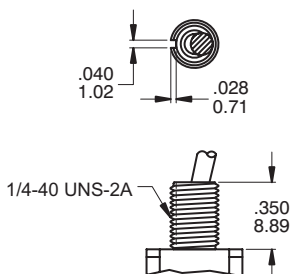

B3 THD B4 NON-THD

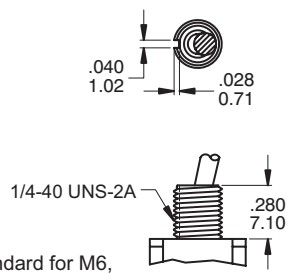

B4 is standard for M6, M7 and VS2~5 termination options.

B5 HIGH TORQUE

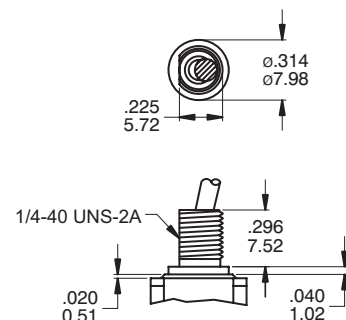

B6 HIGH TORQUE

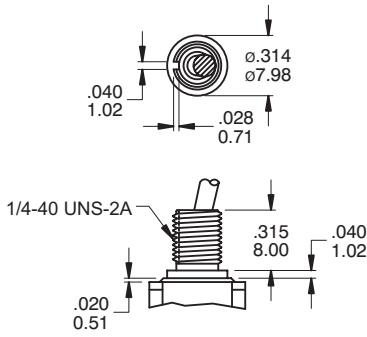

B7 THD STD

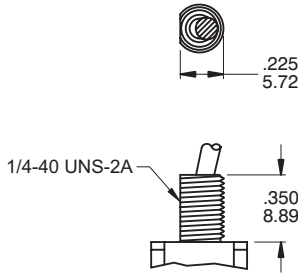

B8 METRIC THD

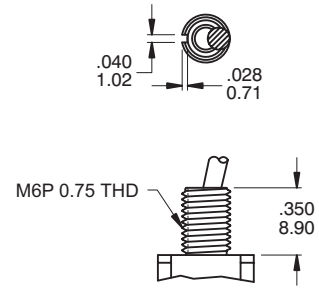

B9 SPLASH PROOF

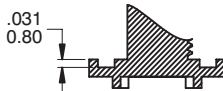
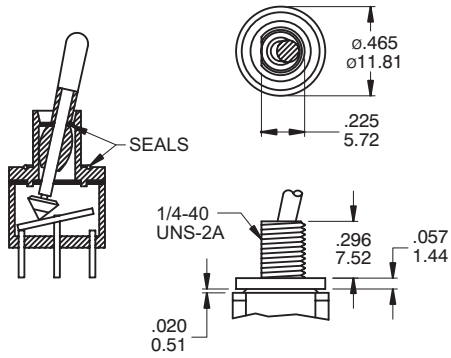

CP-1TEB

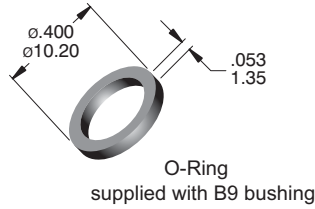

B11 THD STD

B12 NON-THD

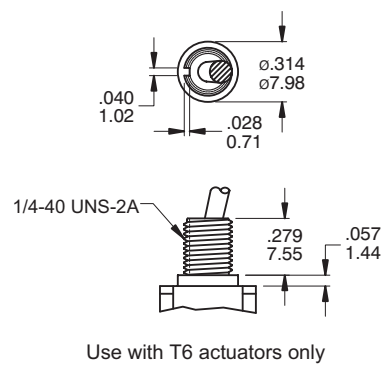

**B15 THD STD
B16 NON-THD**

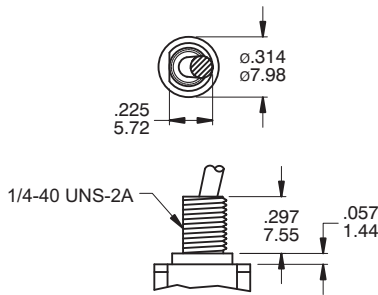

Use with T6 actuators only

B17

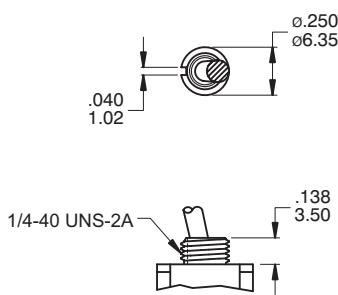

B13

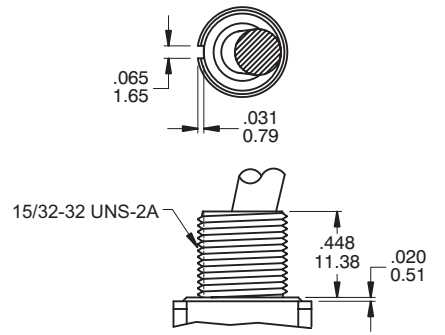

Use with T7, T8 actuators only
B13 Bear strength from top of actuator up to 10kg aside up to 15kg

B14 SPLASH PROOF

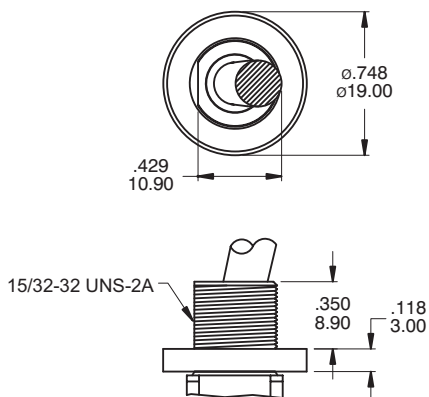

Use with T7, T8 actuators only

B18

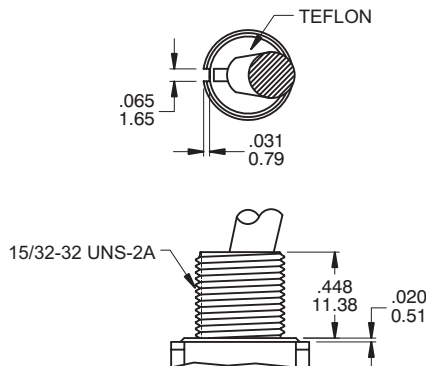

Use with T7, T8 and T10 actuators only with Plastic (Teflon) Insert

B20

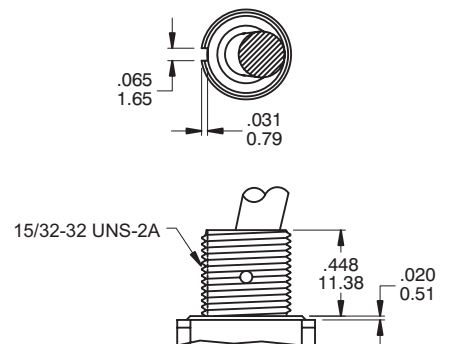

Use with T7, T8 and T10 actuators only

B18, B20 Bear strength from top of actuator up to 20kg aside up to 15kg

PANEL MOUNTING

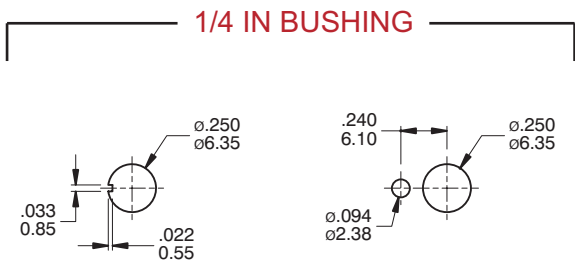

METRIC BUSHING

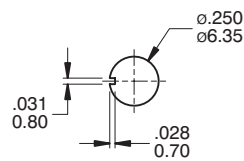

15/32IN BUSHING

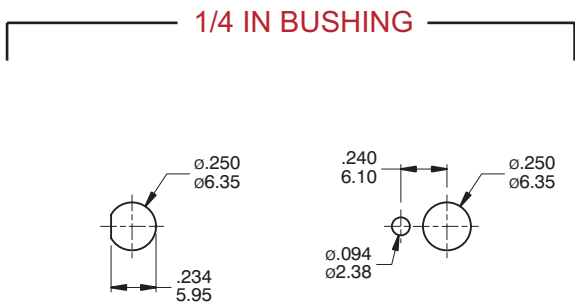
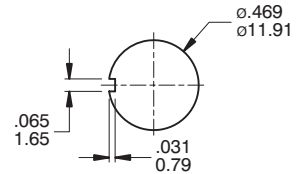

METRIC BUSHING

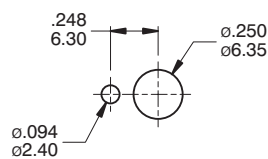

15/32IN BUSHING

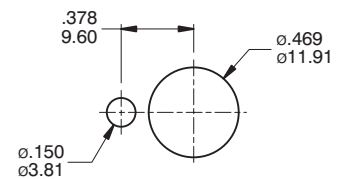

TERMINATION OPTIONS

M1 SOLDER LUG

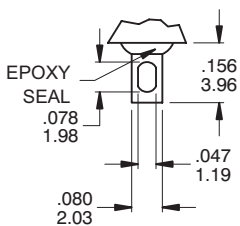

.030(0.76) THK.

M2 PC THRU-HOLE

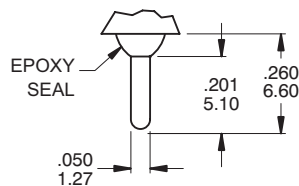

.030(0.76) THK.

M3 QUICK CONNECT

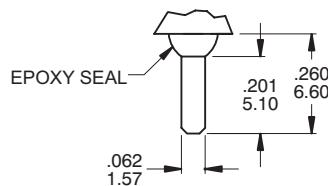

THK .030(0.76)

M5 WIRE WRAP

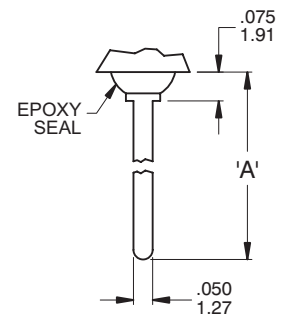

THK .030(0.76)

OTHER TERMINATION OPTIONS

- M6 RIGHT ANGLE P.C. MOUNT
- M7 RIGHT ANGLE P.C. MOUNT
- VS2 VERTICAL BRACKET P.C. MOUNT
- VS3 VERTICAL BRACKET P.C. MOUNT
- VS5 VERTICAL BRACKET P.C. MOUNT

RE Mating Quick Connector
Amp P/N 60900-1

OPTION CODE	DIM. 'A'
M5-1	.736 (18.70)
M5-2	.953 (24.20)
M5-3	.415 (10.55)
M5-4	1.062 (26.97)

M6

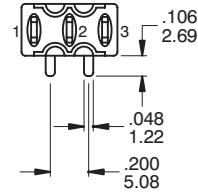
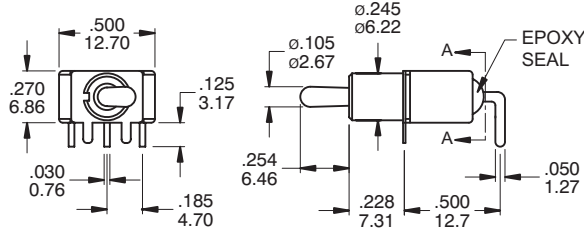
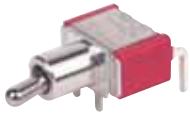

SECTION A-A
TERM. NOS. FOR
REFERENCE ONLY

P.C. MOUNTING

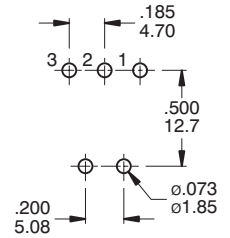

SPDT

Part No. Shown : 1MS1T2B4M6QE

M6

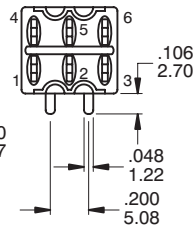
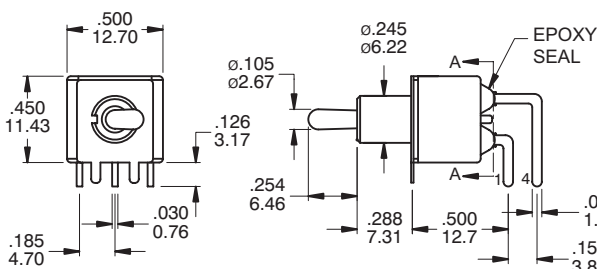

SECTION A-A
TERM. NOS. FOR
REFERENCE ONLY

P.C. MOUNTING

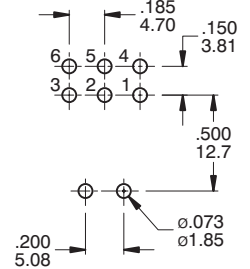

DPDT

Part No. Shown : 1MD1T2B4M6RE

M7

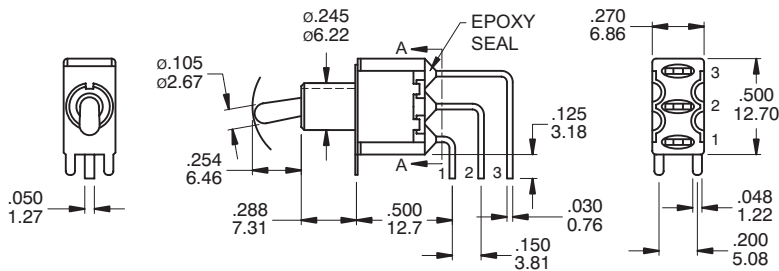
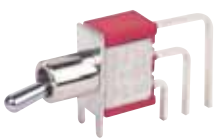

SECTION A-A
TERM. NOS. FOR
REFERENCE ONLY

P.C. MOUNTING

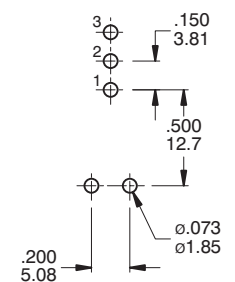

SPDT

Part No. Shown : 1MS1T2B4M7QE

M7

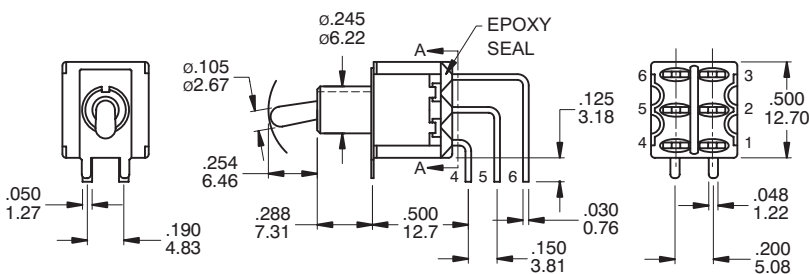
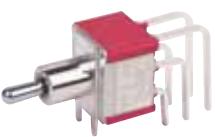

SECTION A-A
TERM. NOS. FOR
REFERENCE ONLY

P.C. MOUNTING

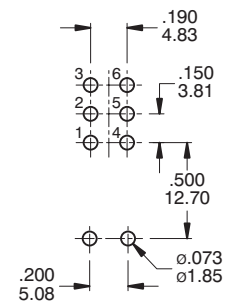

DPDT

Part No. Shown : 1MD1T2B4M7QE

M7

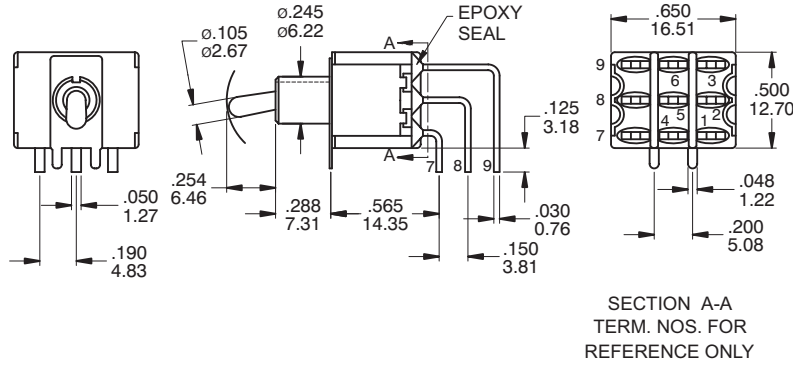
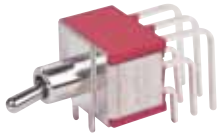

3PDT

Part No. Shown : 1M31T2B4M7QE

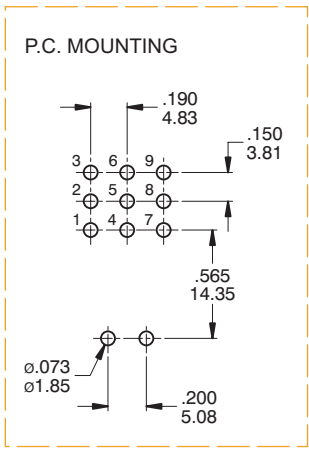

M7

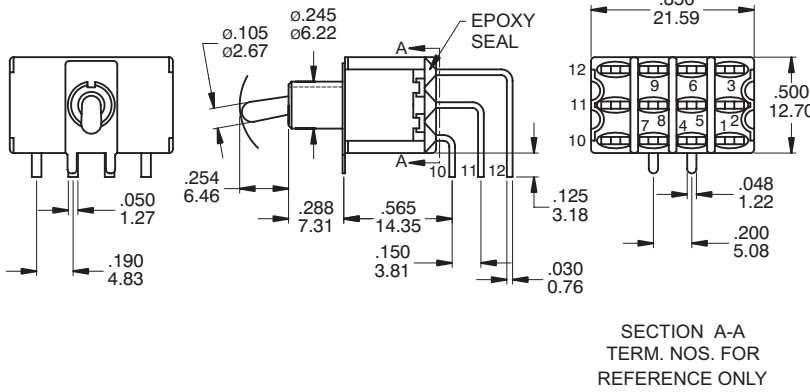
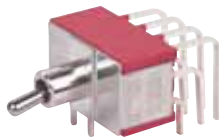

4PDT

Part No. Shown : 1M41T2B4M7QE

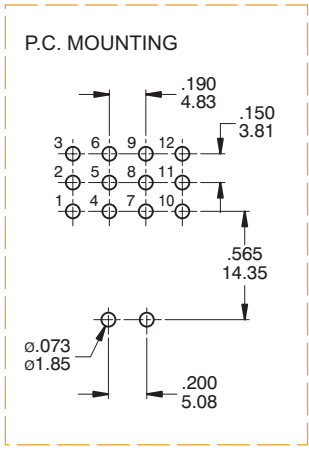

VS2 - VS3

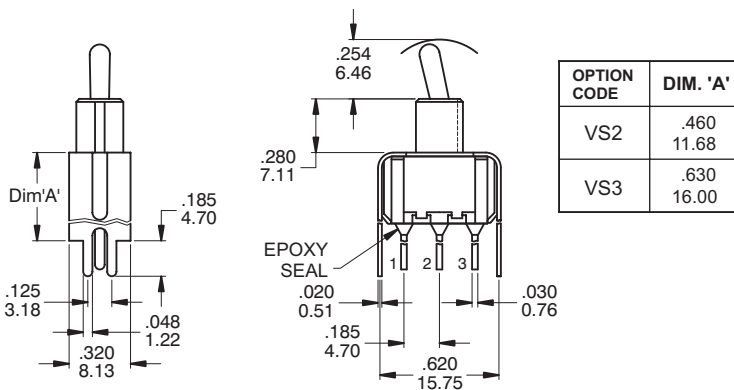

SPDT

Part No. Shown : 1MS1T2B4VS2QE

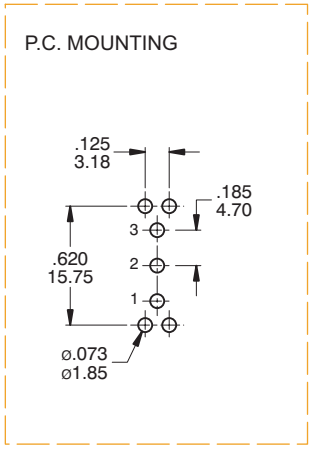

VS2 - VS3

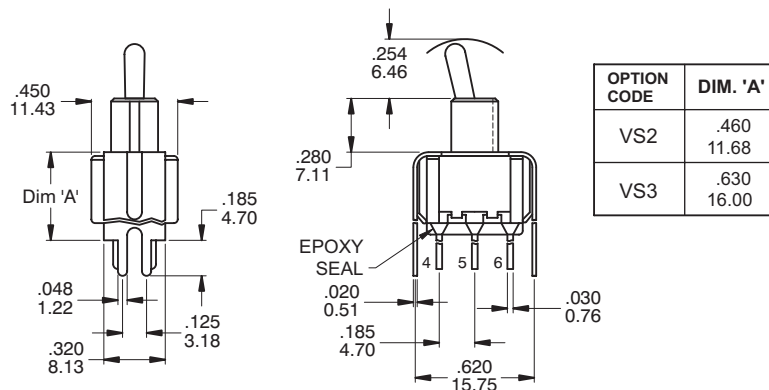

DPDT

Part No. Shown : 1MD1T2B4VS3QE

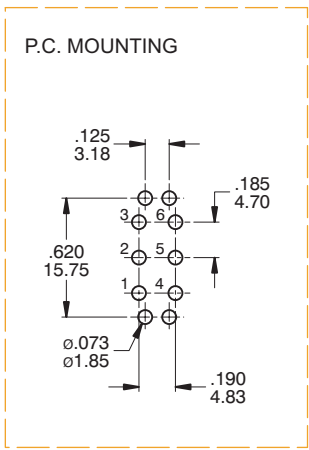

VS5

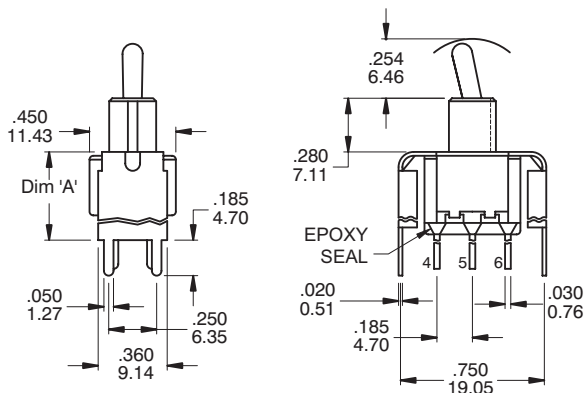

OPTION CODE	DIM. 'A'
VS4	.460 11.68
VS5	.630 16.00

P.C. MOUNTING

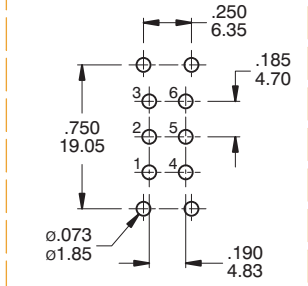

DPDT

Part No. Shown : 1MD1T2B4VS5QE

SNAP-IN TERMINATION OPTIONS

M6N

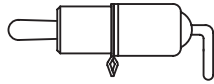
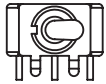

V2N

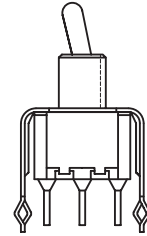

HARDWARE

1/4 NUTS HDW2

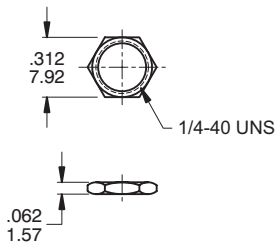

Supplied standard with B1, B3, B5, B6 and B9 options

DRESS NUT HDW3

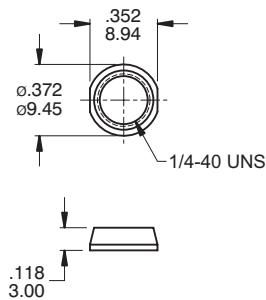

METRIC NUT HDW6

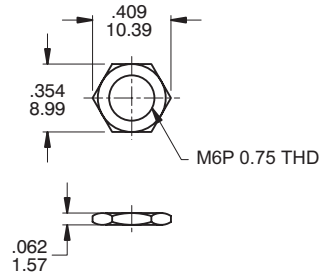

Supplied standard with B8 metric bushing

LOCK WASHER HDW11

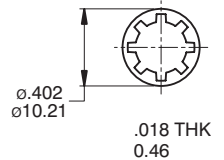

Supplied standard with B1 / B3 bushing

OPTIONAL RUBBER HOOD SEALING

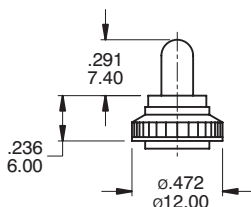

K1=Metric
E1=Inch (Std.)
for actuator T1, T2 and
B1, B3, B5, B6 Bushing only

15/32 NUTS HDW4

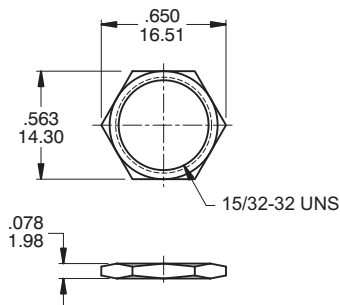

Supplied standard with B13 bushing

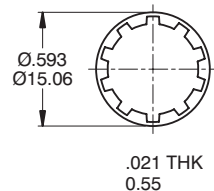

Supplied standard with B13 bushing

Miniature Toggle Switches **1M SERIES**

HDW15

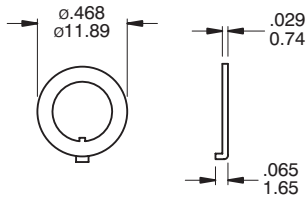

Locking ring supplied standard

HDW16

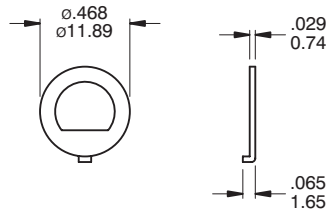

Locking ring supplied with B5 bushing

HDW17

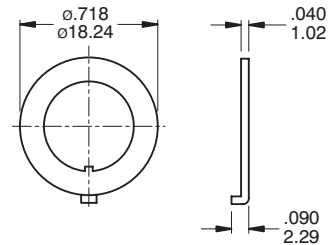

Locking ring supplied with B13,B18,B20 bushing

HDW18

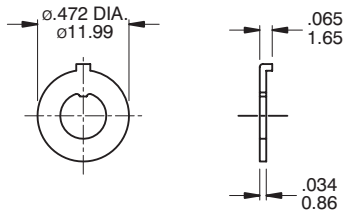

Locking ring supplied with B8 bushing

HDW19

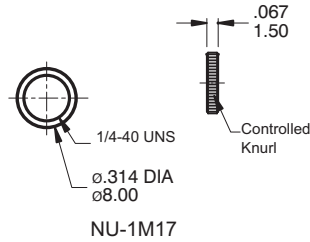

NU-1M17

HDW20

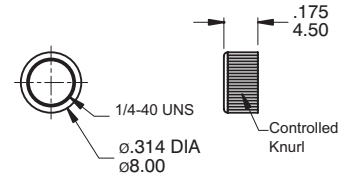

NU-1M24

OPTIONAL TOGGLE CAP

CP-1T1X

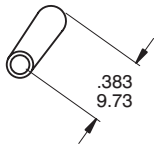

Use with T1

CAP Color :

ITEM NO	COLOR
1	White
2	Black (Std)
3	Red
4	Orange
5	Yellow
6	Green
7	Blue
8	Brown
9	Gray

CP-1T2X

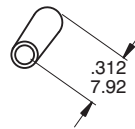

Use with T2

CAP Color :

ITEM NO	COLOR
1	White
2	Black (Std)
3	Red
4	Orange
5	Yellow
6	Green
7	Blue
8	Brown
9	Gray

CONTACT MATERIAL OPTIONS

	CONTACT MATERIAL	TERMINAL PLATING	RATINGS
Q	Silver	Q = Silver	5 Amps with resistant load @ 120VAC or 28VDC 2 Amps with resistant load @ 250VA
S		S = Silver,pure - tin	
C	Gold over Silver	C = Gold over silver	
K		K = Gold over silver,pure - tin	
R	Gold	R = Gold	0.4 Volt - Amps (VA) max. @ 20V max. (AC or DC)
G		G = Gold,pure - tin	



SOLDERING PROCESSES

MANUAL SOLDERING : Use soldering iron of 30 watts, controlled at 350°C approximately 5 seconds while applying solder.

WAVE SOLDERING : Recommended Soldering Temperature : 260 ± 5°C
Duration of Solder Immersion : 5 ± 1 seconds
(PCB is 1.6mm in thickness)

SOLDERING : Vapor phase

Temperature Profile

Zone	Room Temperature	Time (Sec)
Pre-heat (A)	150°C	Min 120s
Soak (B)	180°C ~ 200°C	Min 150s
Peak (C)	200°C ~ 235°C	Min 30s
Peak (D)	235°C ~ 260°C	Min 40s
Peak (E)	260°C	Max 10s

